



UfoEtBlog.com

*The first, absolutely for sure, intellectual contact with ET's.*

See: [www.EtCornGods.com](http://www.EtCornGods.com)

August 18, 2011

James Randi Educational Foundation  
Million Dollar Challenge  
7905 Hollywood Boulevard, # 666  
Los Angeles, CA 90028-6035

Gentlemen

Please find my enclosed Application for the Million Dollar Challenge. Also enclosed are copies of two articles where my work is published – fulfilling the requirement of your rules.

I look forward to hearing from you and winning the \$1,000,000.

Sincerely yours;

George R. Simpson  
PO Box 775  
Hampton Bays, NY 11948  
631-357-9502

# APPLICATION FORM

Full legal name of the Applicant: George Russel Simpson  
Date of birth: September 25, 1937  
Email address: George@etcornegods.com  
Full mailing address: 18 Netz Place, Flanders, NY 11901

Description of the claim to be demonstrated (250 words or less):

I was visited by extraterrestrial presence twenty-six years ago. I have been in contact with ET presence on a daily basis since then. I was told that there was a hidden language in the English language, and that it was my job to decode it and tell it to the world. I have documented thousands of translations. Here: [www.etcornegods.com](http://www.etcornegods.com) and Here: [www.ufoetblog.com](http://www.ufoetblog.com). The decoded words contain English versions of the hidden meanings. Each one is a miracle (proof of the "paranormal"). Certainly thousands of translated words would qualify to win the \$Million challenge.

The encryption (translation) rules are contained here:

<http://www.etcornegods.com/translation.htm> and here:

<http://www.etcornegods.com/reference.htm>

The translation rules involve 1) The base number 66, numbers can be converted to letters and vice-versa; 2) 66 books of the Bible (book position, book name, and book abbreviation); 3) The Periodic Chart of Elements, (Atomic Number, Atomic Symbol, Atomic Name); 4) Arabic and Roman Numerals;

I propose a protocol to test my claim of a different set of decoding criteria, e.g. some other base number than 66; a different list of Bible books, book positions, and book abbreviations; different chart of elements. It is projected that such different translation rules will not produce meaningful translations. Copies attached of my translations published in: <http://www.cropcircleconnector.com/2011/2011.html>

Applicant's signature:  Date: 8/19/11

Notarized or officially certified:

ARLENE CURLEY  
Lic. #6011218  
Notary Public, State of New York  
Qualified in Suffolk County  
My Commission Expires 8-3-14

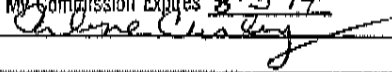

Authorized Representative of the JREF:

Name: \_\_\_\_\_ Title: \_\_\_\_\_

Signature: \_\_\_\_\_ Date: \_\_\_\_\_

**Silbury Hill, Nr Avebury, Wiltshire. Reported  
2nd August.**

Map Ref:

This Page has been accessed

**4742**

Updated Saturday 6th August 2011

<u>AERIAL SHOTS</u>	<u>GROUND SHOTS</u>	<u>DIAGRAMS</u>	<u>FIELD REPORTS</u>	<u>COMMENTS</u>	<u>ARTICLES</u>
03/08/11	03/08/11	03/08/11	03/08/11	04/08/11	03/08/11

## IDIOT SMOKING IN A CROP CIRCLE



I'm sending you this photo taken in the new crop circle at Avebury Trusloe behind Silbury yesterday-the guy in the picture came into the formation with another man and I noticed that he was carrying a cigarette. They proceeded to loudly wander round saying things like 'are there any board marks?' etc ; then I noticed he had lit the cigarette and mentioned it to our American friend who took this photo-he went over to kindly suggest that smoking in a cereal field wasn't a good idea-the response was verbal abuse including-'its my country I can do what I like'. At this point the teacher in me was triggered and I firmly told him why you don't smoke in a ripe field and that it made life even more difficult for those who wished to visit formations. I was told to shut up and that I was trespassing in a farmers field, probably more abuse I care not to remember. When I walked away he tried to provoke even more confrontation by accusing me of walking off!

Please feel free to share this info with other researchers etc. This formation has probably been cut out now as I saw the farmer as I left .he was angry but not abusive.

**ARE**

---



[CLICK HERE FOR THE LATEST CROP CIRCLE CONNECTOR DVD](#)

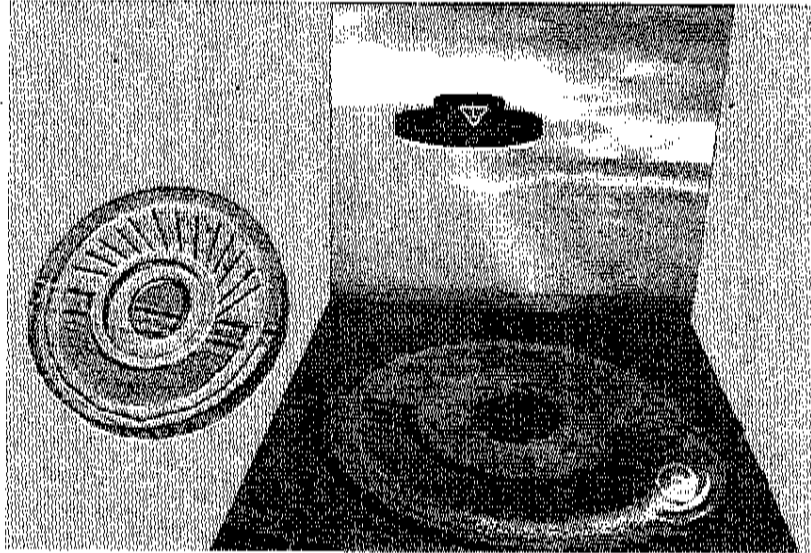

**THE 'FREE ENERGY' ROTARY PLASMA DRIVE PROPULSION SYSTEM - THE KEY TO YOUR FUTURE**

Artwork by WJ

**facebook**

Discuss this circle on our Facebook

[OUR CROP CIRCLES FACEBOOK](#)



Make a donation to keep the web site alive... Thank you

**CROP CIRCLE ETIQUETTE**

Guidelines for visiting formations

## The crop circle "Silbury Hill, Nr Avebury, Wiltshire, England" – The "Funny Face" Crop Circle.

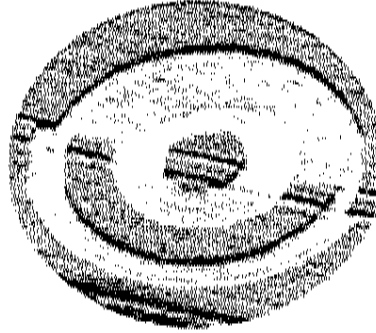

Note:

Translated words like "Circle, Half, Mouth, Nose, etc.", in the name or location of Crop Circles indicate unusual relationships between the character positions in the word(s) being translated and result of the translation.

God (UFO/ET) talks to us through the ET Corn Gods language translation of words.

Words and groups of words are like computer programs which explode into a family of predetermined meanings.

The Crop Circles are created by GOD to introduce the ET Corn Gods Language/Game.

This Crop Circle is a "Funny Face" with a nose and mouth — no eyes.

Circle:

Ci is 39, book "Mal".

Mal:

M is 13, book ach = a C H, "Ha".

Al backwards is 121, backwards is 121, "La", "Laugh". (add 0+66+66 ... = "UGH").

Therefore:

Ci = "Ha Laugh".

H is 18, Old Testament 8, "Ru" = "HA".

Therefore:

Cir = "Ha Laugh Ha".

C is "Carbon", "Nobra".

N is 14, book 2 ch, bc 8, book RU = "Ha".

o+66 = "Ha".

Bra = ta, ta-66-66 = "C", Carbon.

Therefore:

C = "Ha Ha Ha Ha Ha Ha ...."

Circ = "Ha Laugh Ha, Ha Ha Ha Ha ....".

Le is 55,  $55+66 = 121$ , "La", "Laugh", (add  $0+66+66 \dots = \text{"ugh"}$ )

Circle = "Ha Laugh Ha, Ha Ha Ha Ha ....Laugh".

Le = 125, Ay =  $0+66+66 \dots$  ay, "Play".

Therefore:

Circle = "Ha Laugh Ha, Ha Ha Ha Ha ....Laugh".

Half: (Silbury Hill is a *Half Circle*)

H is 8, book Ru = ah u = "Ha".

O + 66 .. = "Ha".

al backwards is La, 121, backwards is 121, "La", "Laugh". (Add  $0+66+66 \dots = \text{"ugh"}$ ).

F is "Fun". (Add  $0+66+66 \dots = \text{"Mt"}$ , book 40, backwards is 04, book Nu, backwards is "UN")

Therefore:

Half = "Ha Laugh Fun".

Half Circle = "Ha Laugh Fun, Ha Laugh Ha, Ha Ha Ha Ha ....Laugh".

Mouth:

M is 13, book I ch = "Ha".

O+66+66 .. = "Ha".

Uth = bath.

Therefore:

Mouth = "Ha Ha Bath".

Ath = I th, book 52.

Therefore:

Bath = "b 52",  $2+52, 54$ , backwards is 45, book "Ro", backward is "Or".

O+66 = "Ha".

Therefore:

Mouth = "Ha Ha Har".

Nose:

N is 14, book 2ch = BC 8, book "Ru", "Ha".

O+66 = "Ha".

S+66 = "He", H+c = "M", 13, book I Ch = "Ha".

c is 5, book "Dt", D+T = "24",  $2+4 = 6$ , F, "FUN". (See above).

Therefore:

Nose = "Ha Ha Ha Fun".

*Note:* All the Bible names convert to some form of "Ha", "Laugh", "Har", etc.

Example: Adam = "Ha Ha Ha Ha".

Remember the God of comedy is the God of the Bible, and Heaven and Earth. The Crop Circles are of "GOD", to introduce the ET Corn Gods language – and the first, Absolutely For Sure. Intellectual Appearance of God on earth.

See: [www.ufoetblog.com](http://www.ufoetblog.com) and click on "Bible Names".

Visit: [www.ETCornGods.com](http://www.ETCornGods.com) and [www.ufoetblog.com](http://www.ufoetblog.com)

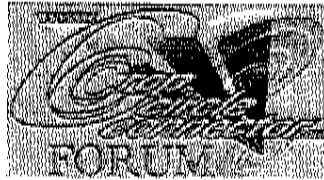

**[Click above to join the Crop Circle Connector Membership](#)**

**iContact**

Document  
New Age  
iContact.com

Up to 65% off  
New Books

Change the way you do  
business. **Start for FREE!**

**FREE TRIAL**



**BACK**

*@mark*

**Mark Fussell & Stuart Dike**

See Page 16

**Temple Farm, Nr Rockley, Wiltshire. Reported  
7th August.**

Map Ref:

This Page has been accessed

**13011**

Updated Monday 15th August 2011

<u>AERIAL SHOTS</u>	<u>GROUND SHOTS</u>	<u>DIAGRAMS</u>	<u>FIELD REPORTS</u>	<u>COMMENTS</u>	<u>ARTICLES</u>
08/08/11	08/08/11	10/08/11	08/08/11	15/08/11	08/08/11

**Subatomic physics as shown in crops at Temple Farm: a code in ternary base-3 for possible discovery of the Higgs particle on August 7, 2012, using an ATLAS detector at the Large Hadron Collider in CERN**

The new crop picture at Temple Farm clearly shows a code in ternary base-3 for two dates of August 7, 2011 or August 7, 2012, although that does not explain its significance. Clare Kingston and Jack Sullivan have both suggested that the crop image shown at Temple Farm might represent a national English synchrotron at Harwell, called the "Diamond Light Source". While investigating their hypothesis, I have made a series of remarkable discoveries.

First, the crop picture shown at Temple Farm actually resembles an *ATLAS subatomic particle detector* in CERN, located at the Large Hadron Collider:

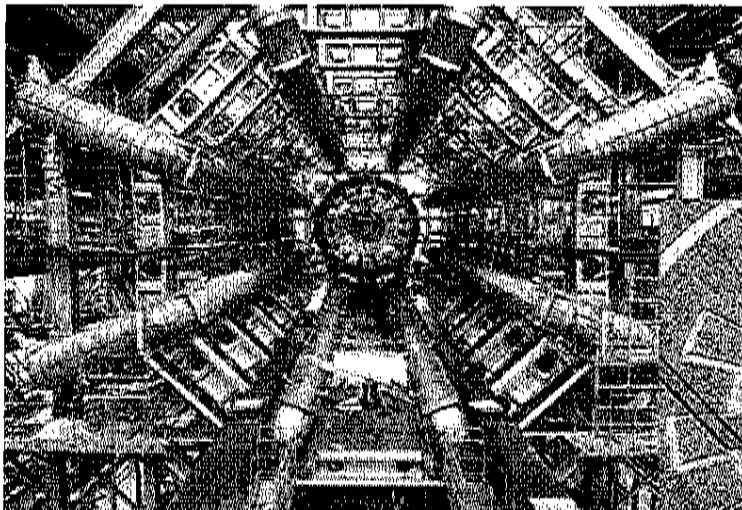

*Temple Farm of August 7, 2011 also shows an image of the ATLAS particle detector at the LHC*

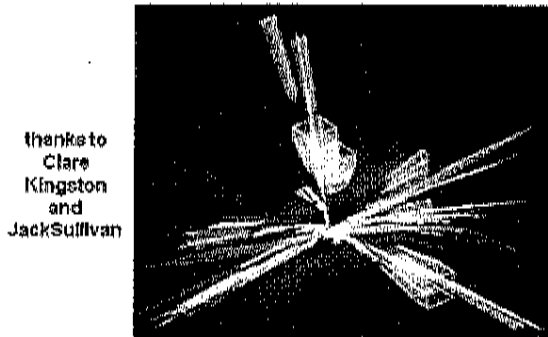
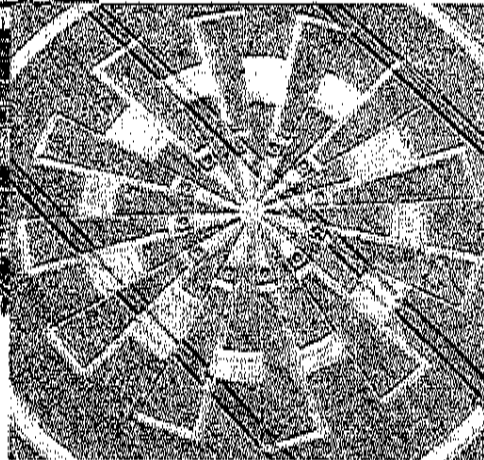

thanks to  
Clare  
Kingston  
and  
Jack Sullivan

**"Physicists from the Large Hadron Collider said that the Higgs particle continues to elude them. Yet they expect to know within a year whether that particle really exists." July 25, 2011**

Next, the inner part of that crop picture shows a series of rays of different length, and resembles a *UA1 detector* which was used to discover the W or Z bosons some years ago. On July 25, 2011, physicists from CERN held a press conference to



announce that the long-awaited Higgs particle still eludes them, yet they expect to know within one year whether that particle really exists. Perhaps on August 7, 2012?

How might Harwell come into it? That national English synchrotron, known as the *Diamond Light Source*, was seemingly shown in crops at Hodson on July 30, 2008:

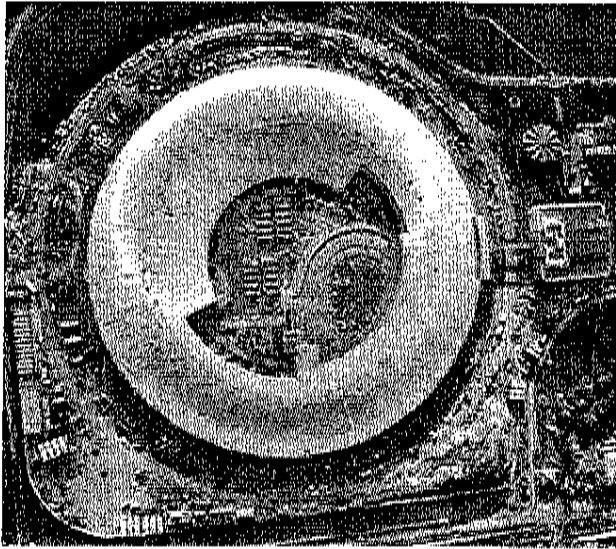

*Hodson of July 30, 2008 showed an image of the Diamond Light Source at Harwell, England*

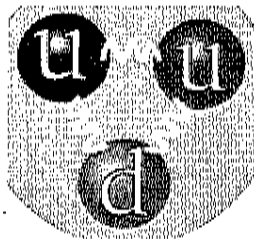
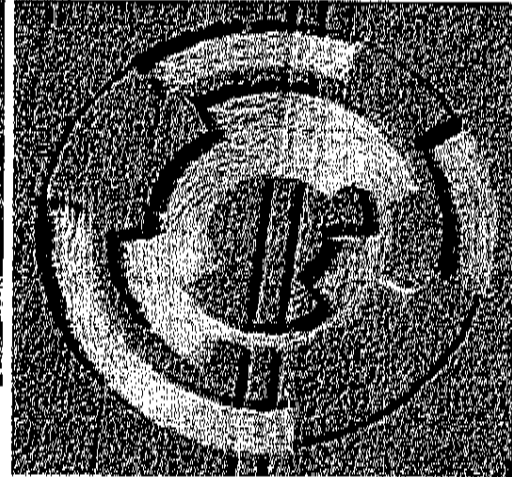

three quarks

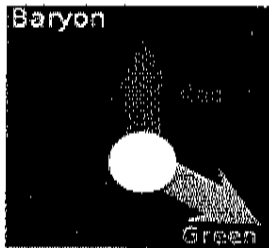

three colors

Subatomic physics uses several codes in base-3. Hence the ternary code at Temple Farm saying "one year" or August 7, 2011 to August 7, 2012 for possible discovery of a Higgs particle.

Current theories of subatomic physics use *several codes in ternary base-3* for the number of quarks in any baryon, or the number of colours for any quark. This is surely why our crop artist, in the context of both ATLAS and UA1 detectors, used a ternary code to provide two dates of August 7, 2011 or August 7, 2012. Those two dates define a period of *one year* in which physicists from CERN might discover the Higgs particle, as discussed at a press conference on July 25, 2011.

Red Collie (Dr. Horace R. Drew)

Temple Farm of  
August 7, 2011  
shows a code in  
ternary base-3 for  
its date and time  
of formation as  
7 (day)-8 (month)-  
0100 (hour)-2011  
(year)

021 22 01 202 1 1  
in ternary  
equals  
7 8 01 2011 in  
decimal

CMMResearch

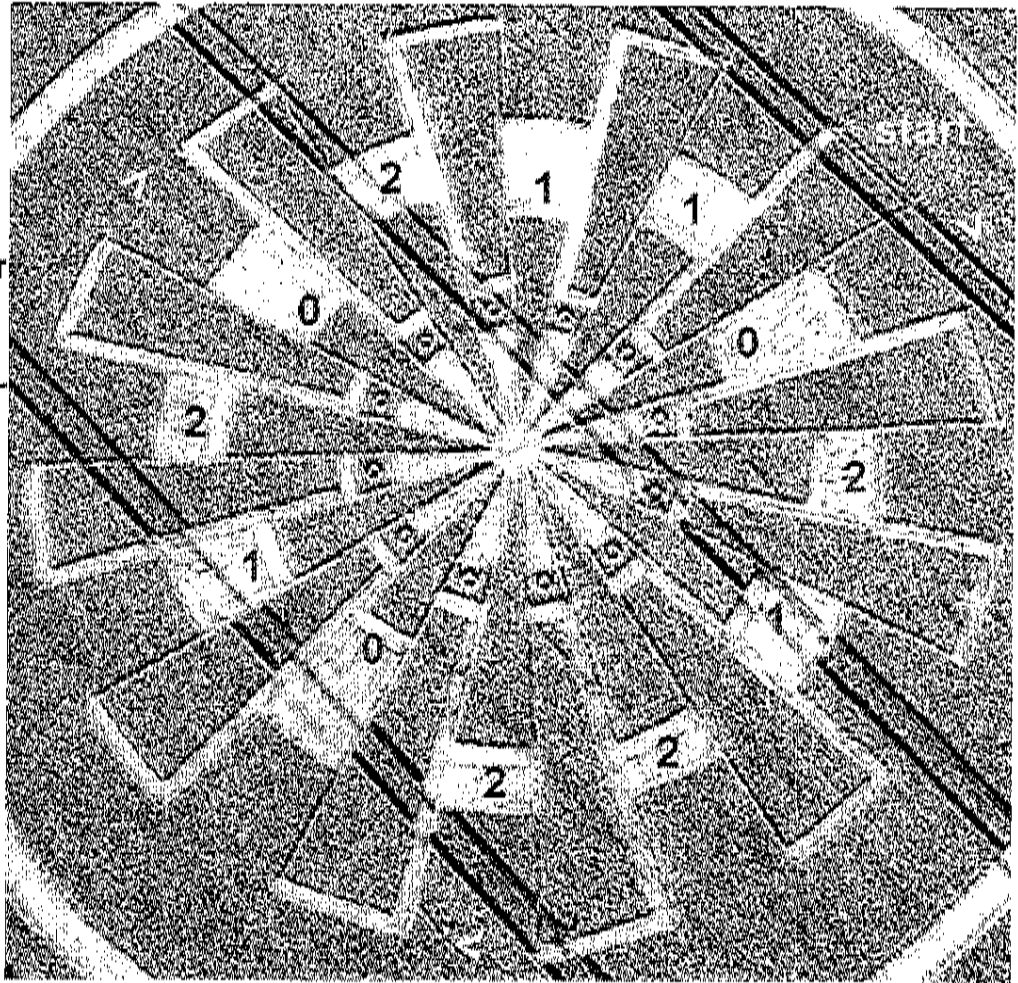

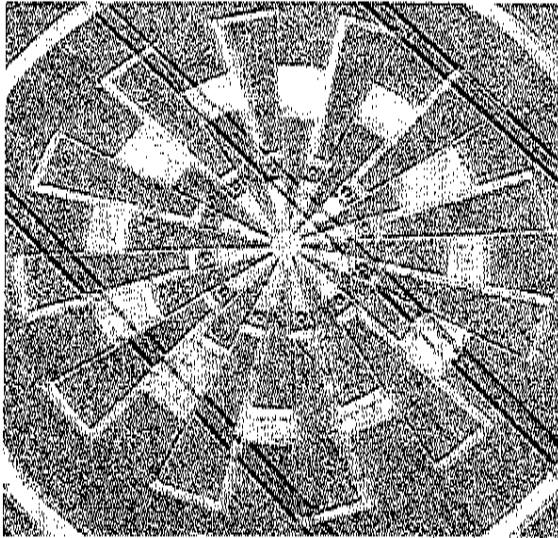

**August 7, 2011**  
**ternary code for the current date**  
**07-08-2011 at 0100 hours**

**Were these two crop pictures made  
by the same artist?**

**CMMResearch**

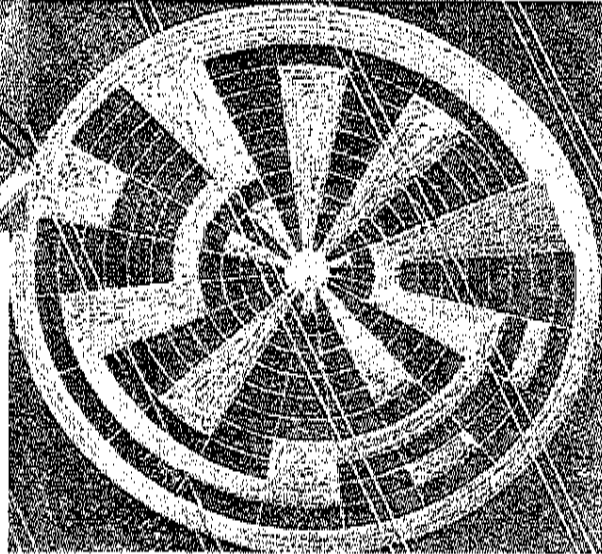

**June 21, 2009**  
**golden ratio 1.61803399**

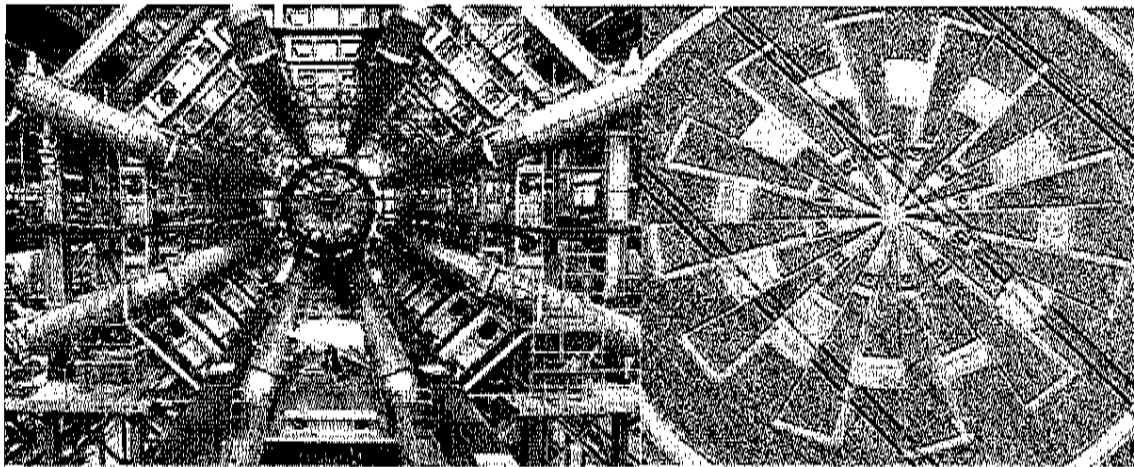

**Temple Farm of August 7, 2011**  
**resembles both the ATLAS**  
**and CMS detectors being used**  
**at a Large Hadron Collider in**  
**CERN, to search for the**  
**elusive "Higgs particle" in**  
**2011 or 2012**

**CMM Research**

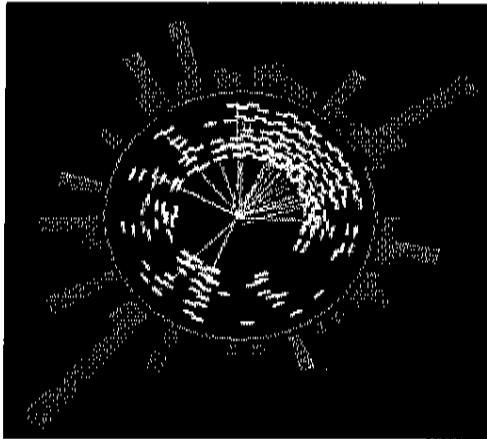
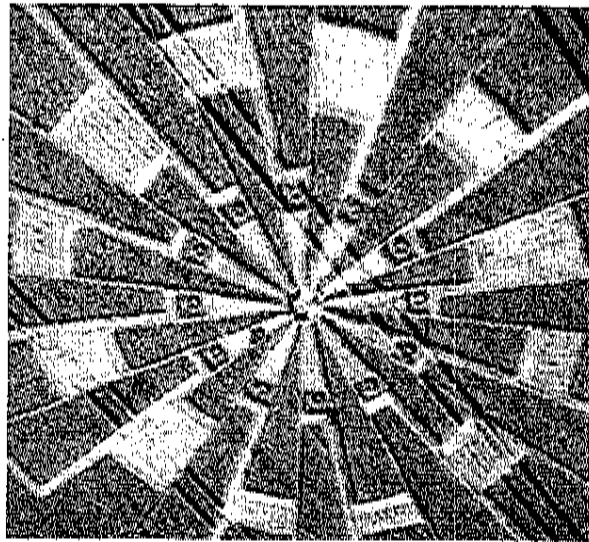
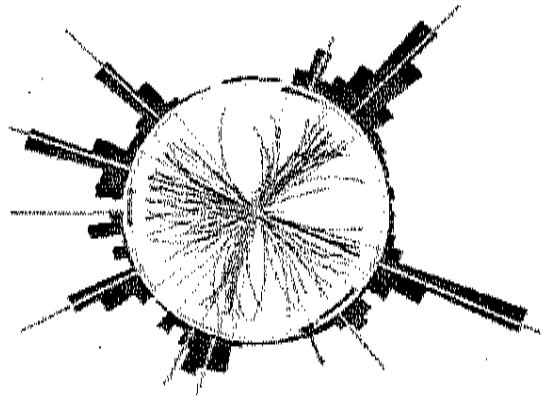

**The inner part of Temple Farm shows a series of "rays" which resemble the results of a particle collision event.**

**Those "rays" were coded in length to give two dates of August 7, 2011 or August 7, 2012 in ternary base-3.**

CMM Research

**Three anomalies of length from highly-vertical aerial photographs of Temple Farm on August 7, 2011: a second code for one year later on August 7, 2012?**

As reported earlier (see slides at the top of this page), the major code at Temple Farm was written in ternary base-3 as **021 22 01 202 1 1**. That series of numbers converts to **7 8 01 20 1 1** in decimal base-10 (see [www.mathsisfun.com](http://www.mathsisfun.com)). Such decimal numbers match a calendar date of 07-08-2011 or August 7, 2011 in the early morning hours of 0100 when that crop picture appeared.

The Temple Farm crop picture does not seem to be coded in decimal base-10, as helpfully suggested above by Laurent Kalensky. For example, it shows no concentric grid lines as were shown in a similar but decimal-coded crop picture at Pewsey on June 21, 2009. Such grid lines would be needed for anyone to read decimal numbers reliably from aerial photographs.

More recently on August 9, 2011, several "highly vertical" aerial photographs became available (see [www.silentcircle.co.uk](http://www.silentcircle.co.uk)). From a careful study of those photographs, we have now been able to find *three anomalies* away from its major ternary code:

**Three anomalies  
of length from  
more-vertical  
aerial  
photographs**

**0 = 1.00, 1.00, 1.00**

**2 = 1.30, 1.30, 1.29,  
1.29, 1.23 (short)**

**1 = 1.13, 1.13, 1.11  
(short)**

**1 or 2 = 1.21**

**021 22 01 202 1 1  
or 2 in ternary**

**7 8 01 2011 or  
2012 in decimal**

**CMM Research**

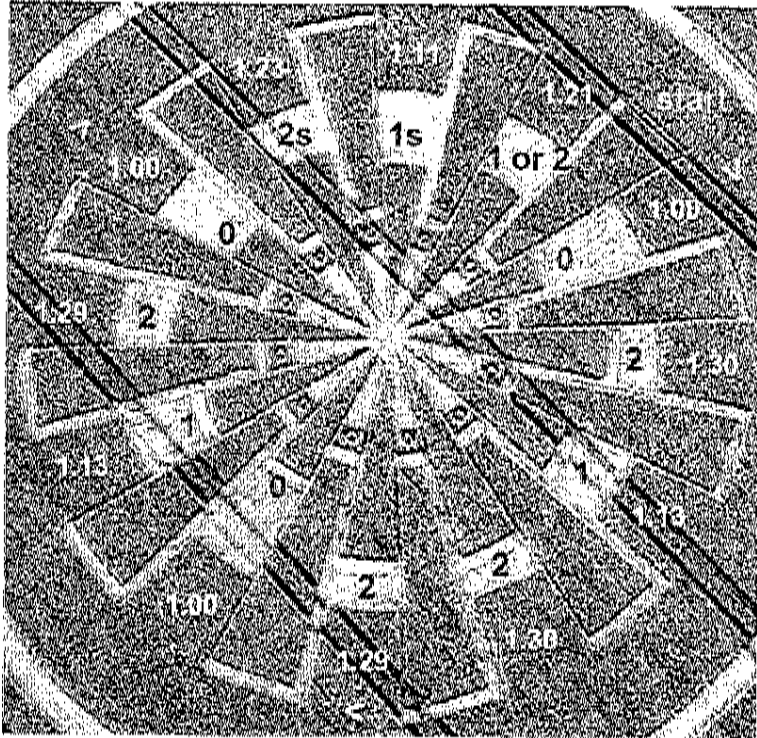

Idealized values of length for ternary numbers “0”, “1” or “2” were drawn at Temple Farm as 1.00, 1.13 or 1.29 respectively, for digits one to nine in a twelve-spoke wheel. Yet in the last three digits we can see three anomalies: digit ten is “2” but slightly short, digit eleven is “1” but slightly short, while digit twelve could be either “1” or “2” based on its intermediate value of length.

The first two anomalies could be due to slight errors in measuring from aerial photographs. If someone would like to go out into the field with a long tape measure, and determine such values directly, that would be appreciated!

The last anomaly seems more significant, and far beyond any possible error of measurement. Basically the twelfth digit of that ternary code lies halfway between “1” and “2”. In the former case, we would read a current date of *August 7, 2011*. In the latter case, we would read a near-future date of *August 7, 2012*. Will anything important happen exactly one year from now?

*Red Collie* (Dr. Horace R. Drew)

I think this crop circle is a representation of the Diamond Light Source Synchrotron in Harwell, Oxfordshire:

[www.harwelloxford.com](http://www.harwelloxford.com) OR [www.diamond.ac.uk](http://www.diamond.ac.uk) OR [Synchrotrons](#)

which I find exciting! Also another link that is relevant as there are clues in the circle that matches this image (The booster synchrotron the little curls in the inner circle and the angles like the triangles on the circle) (The middle circle looks like the building itself and the outer ring the road around it all):

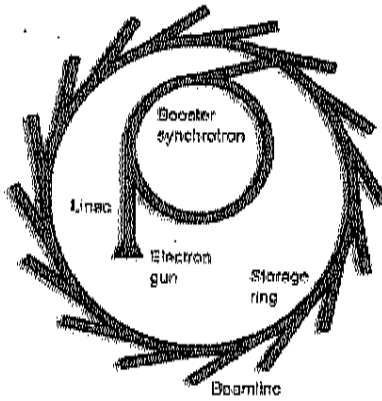

<http://www.diamond.ac.uk/Home/About/Synchrotrons/Machine.html>

#### About Diamond | How do synchrotrons work?

Particles called electrons are generated in an electron gun, very like the cathode ray tubes found in old television sets. They are then accelerated up to very high speeds through a series of three particle accelerators. These are called the linear accelerator, or linac, the booster synchrotron and the large storage ring. The storage ring is not a true circle, but a polygon, made of straight sections angled together with bending magnets. These bending magnets (also called dipole magnets) are used to steer the electrons around the ring. As the electron passes through each magnet it loses energy in the form of light. This light can then be channelled out of the storage ring wall and into the experimental stations, called beamlines. Third generation synchrotrons like Diamond also use special arrays of magnets called insertion devices which placed in the straight sections of the ring. These cause the electrons to follow a wiggling path, which produces more intense and tuneable light.

Clare Kingston

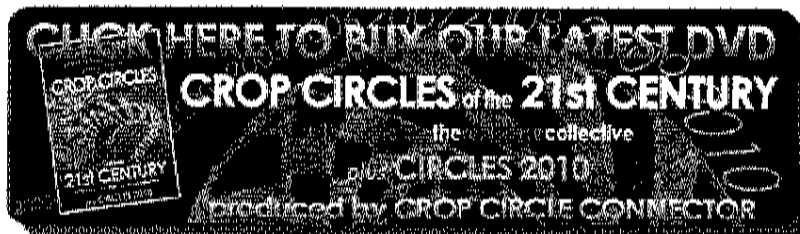

[CLICK HERE FOR THE LATEST CROP CIRCLE CONNECTOR DVD](#)

I want to talk about crop Temple Farm, Nr Rockley, Wiltshire. Reported 7th August. I think that speaks of the zodiac and the signs are the same size and astrological houses are uneven, there are 12 signs and 12 houses, the number 144 is implicit in the agrogilfo, perhaps referring to the input of 0 degrees the constellation Libra, in equinox.

**equinoccio**

Vemas 23 Septiembre de 2011  
 Córdoba Capital - Córdoba  
 Argentina  
 Long: 64W11 Lat: 31S24  
 Hora nacimiento: 11:09  
 Tiempo Universal: 15:09

Signo Solar: Libra  
 Signo Lunar: Leo  
 Signo Ascendente: Capricornio

Planetas en Signos		Casa
☉ Sol	0° 14' Libra	IX
☾ Luna	7° 34' Leo	VII
☿ Mercurio	25° 52' Virgo	X
♀ Venus	10° 35' Libra	IX
♂ Marte	2° 46' Leo	VII
♃ Júpiter	9° 23' Tauro	II
♄ Saturno	17° 44' Libra	IX
♅ Urano	2° 40' Aries	III
♆ Neptuno	28° 42' Acuario	XI
♇ Plutón	4° 54' Capricornio	IX
Ascendente	0° 29' Capricornio	IX
Medio Cielo	13° 55' Virgo	X

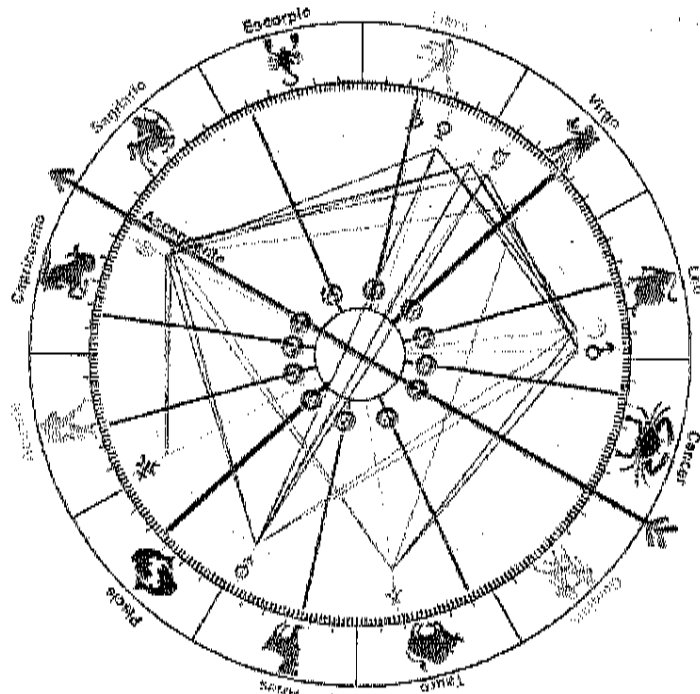

[www.astro.com](http://www.astro.com)

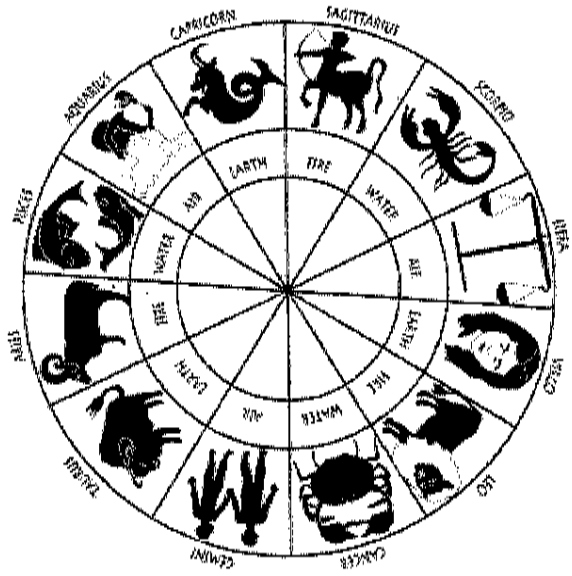

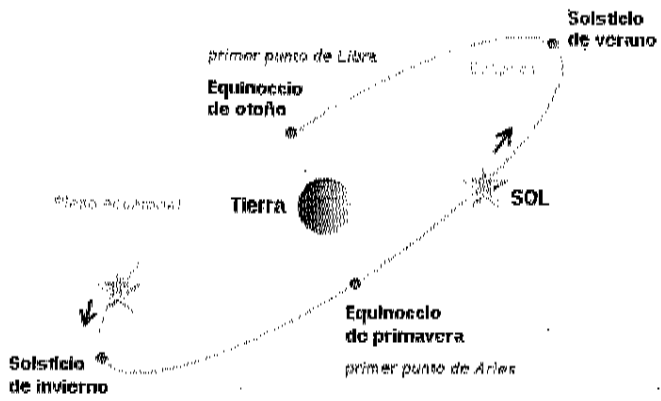

While the crop circle Furze Knoll, Bishop Cannings, Wiltshire. Reported 6th August. . I think it also refers to the entrance of the galactic plane, this equinox. I leave my blog I made a note about the galactic plane may be able to draw any picture, a big hug and many blessings (forgive me my English is that I use googlettranslator)

<http://masalladeescorpio.blogspot.com/2011/08/entrando-al-plano-galactico.html>

**Emiliano Icardi**



Discuss this circle on our Facebook

**OUR CROP CIRCLES FACEBOOK**



Make a donation to keep the web site alive... Thank you

This afternoon I was at work (I'm a Paramedic, without a lot of work today... and I looked at the formation of yesterday. And something was telling me... That's not the right interpretation 0, 1, 2... There are more than those numbers. So, I made this in Word and I founded these series of numbers. But I didn't know what it means, I'm not an important crop circle geek yet :)



The pattern indicates the movement of consciousness to a higher dimension - all in harmony with a minor and benign shift in the magnetic Poles of the earth.

The aerial craft first deploys orbs of electrical plasma to electrically charge the field. Then the pattern is inscribed in the field by projecting geomagnetic scalar waves from above in fast pulsing strobes that produce the lay in the crop.

Artwork by W.J



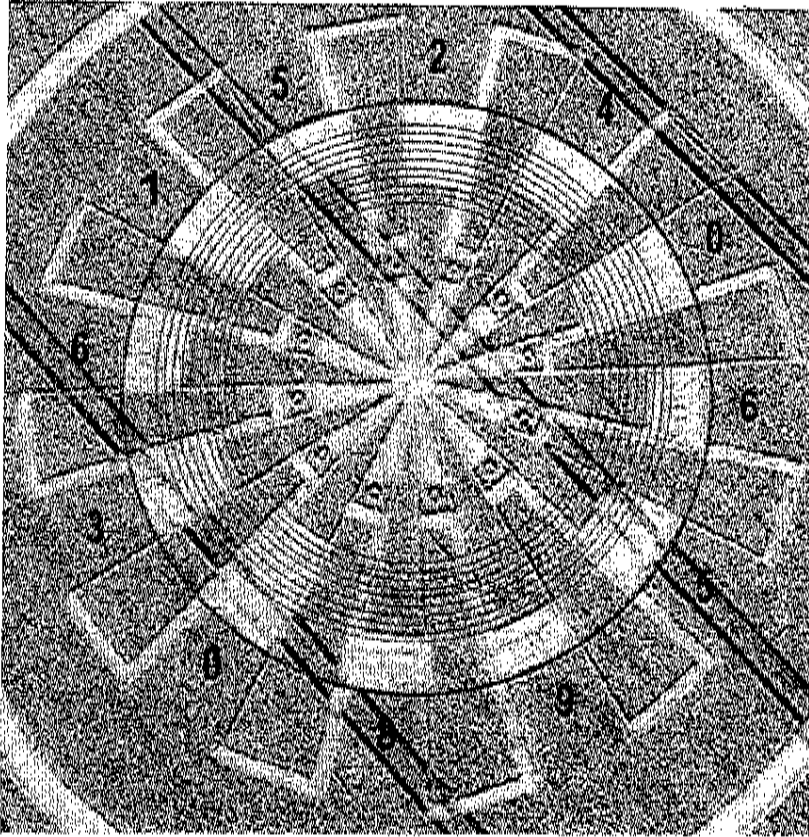

clockwise:  
0659803615240  
or  
0361524065980  
the opposite  
0425163089560  
or  
0895604251630

Laurent Kalensky

---

**CROP CIRCLE ETIQUETTE**  
Guidelines for visiting formations

---

The Temple Farm CC suggests a safety lock. The small triangles of different sizes are aligned as if the key it was inserted. They are pushing the walls of the outer circle and gives the impression that its opening is in progress....

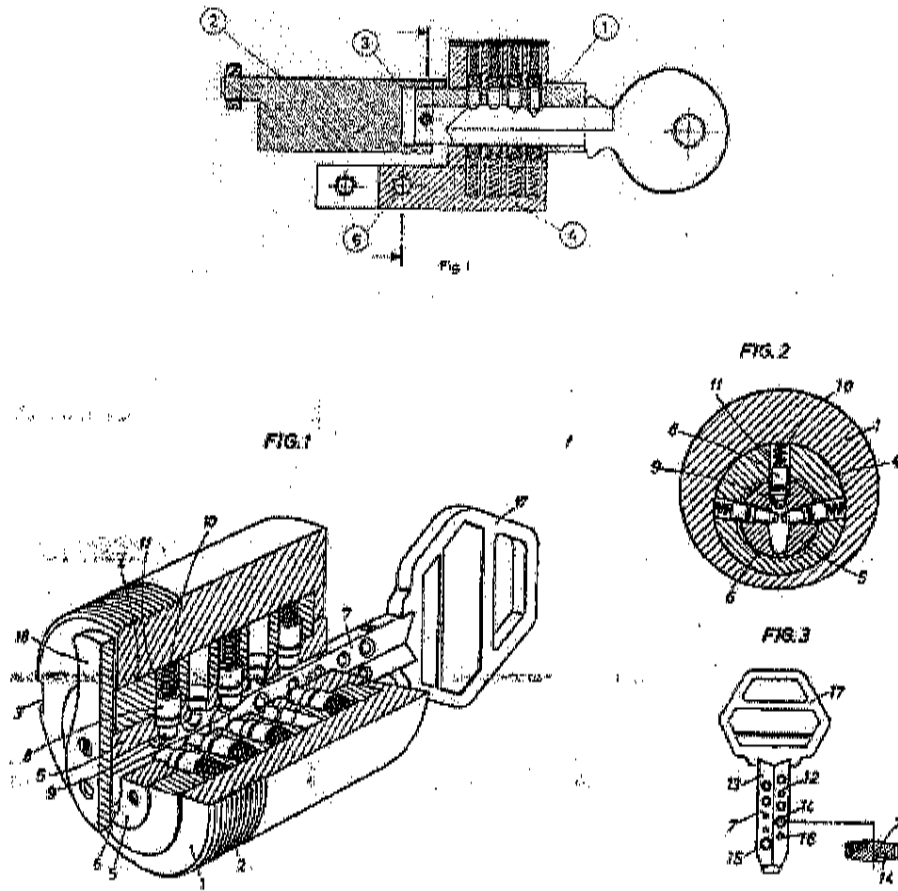

**Fernando Roy**



Clare Kingston's 'Comment' seems to be spot on in relating it to the Harwell Diamond Light Source Synchrotron which is based just south west of Didcot Oxon. Find it on Google Maps and zoom in on it from directly overhead Like Clare says, the correlation is amazing and cannot be an accident. Note the twelve divisions of the roof and how the much smaller "Boost Synchrotron" unit, to the south west of the big circle has been planted into the centre of the formation.

Incidentally, with all respect to CMM Research and Collie, the 'Ternary base 3" solution of theirs seems very tenuous. All the detail of the formation is very precise and the ring of differently sized blocks must be intentional. They really cannot be matched to give the numerical values as CMM show. From past experience I can't believe the circle creators would allow the significant differences in lengths of supposedly same value blocks, Check the 0s, 1s and 2s. There must be another reason for these differences but I have no idea what it may be at this stage. In any case what would be the point of the creators giving us the date of the arrival, a fact we are already fully aware of.

**Jack Sullivan**

[Click above to join the Crop Circle Connector Membership](#)

I would like to thank Mr Laurent Kalensky precisely processed image. I noticed that in the list there are included digits 1 to 9 except number 7. I believe that there is a mistake. Sector No. 8 and 9 could be distorted by prolongation of the photo at the bottom. If my assumption was correct, I would correct the two segments to the value of 7 and 8. Number of the occupied sections in the sectors I interpreted as a digit 1, unoccupied piece as 0. This i show I get digits in binary system ranging from 128 to 255. This is very important because this layout agrees with the layout of ASCII table. I think that there is not any specific message encoded in this formation, but it is just a notifications for this code. Range from 128 to 255 is a very specific and depends on the type of font.

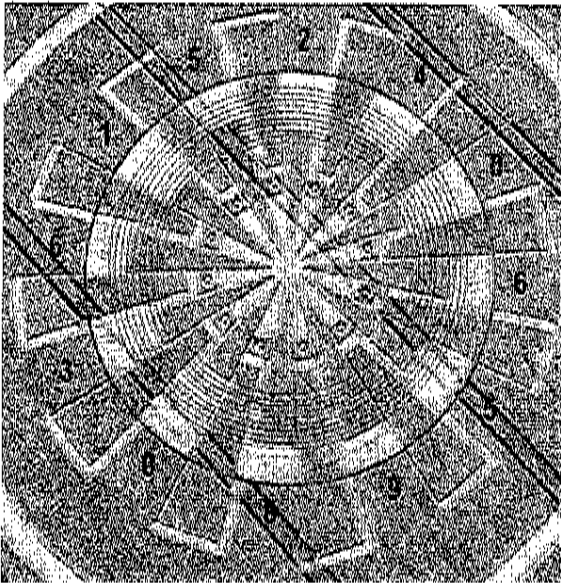

number of divisions	binary code	decimal system
1	= 1 0 0 0 0 0 0 0	= 128
2	= 1 1 0 0 0 0 0 0	= 192
3	= 1 1 1 0 0 0 0 0	= 224
4	= 1 1 1 1 0 0 0 0	= 240
5	= 1 1 1 1 1 0 0 0	= 248
6	= 1 1 1 1 1 1 0 0	= 252
7	= 1 1 1 1 1 1 1 0	= 254
8	= 1 1 1 1 1 1 1 1	= 255
? 9	= 1 1 1 1 1 1 1 1	= 511

The first 32 characters in the ASCII-table are unprintable control codes and are used to control peripherals such as printers.

Codes 32-127 are common for all the different variations of the ASCII table, they are called printable characters, represent letters, digits, punctuation marks, and a few miscellaneous symbols. You will find almost every character on your keyboard. Character 127 represents the command DEL.

For extended ASCII codes (character code 128-255), there are several different variants of 8-bit ASCII table.

# <http://www.table-ascii.com/>

Dec	Hex	Char
128	80	Ç
129	81	ü
130	82	ë
131	83	â
132	84	ä
133	85	å
134	86	ç
135	87	È
136	88	é
137	89	ê
138	8A	ë
139	8B	ì
140	8C	í
141	8D	î
142	8E	Ï
143	8F	Ä
144	90	É
145	91	æ
146	92	œ
147	93	ô
148	94	õ
149	95	ö
150	96	ù
151	97	ú
152	98	ÿ
153	99	ÿ
154	9A	Ü
155	9B	Ë
156	9C	Ë
157	9D	Ë
158	9E	Ë
159	9F	f

Dec	Hex	Char
160	A0	á
161	A1	í
162	A2	ó
163	A3	ú
164	A4	ñ
165	A5	Ñ
166	A6	à
167	A7	ó
168	A8	ç
169	A9	¸
170	AA	¸
171	AB	½
172	AC	¼
173	AD	¸
174	AE	«
175	AF	»
176	B0	¸
177	B1	¸
178	B2	¸
179	B3	¸
180	B4	¸
181	B5	¸
182	B6	¸
183	B7	¸
184	B8	¸
185	B9	¸
186	BA	¸
187	BB	¸
188	BC	¸
189	BD	¸
190	BE	¸
191	BF	¸

Dec	Hex	Char
192	C0	¸
193	C1	¸
194	C2	¸
195	C3	¸
196	C4	¸
197	C5	¸
198	C6	¸
199	C7	¸
200	C8	¸
201	C9	¸
202	CA	¸
203	CB	¸
204	CC	¸
205	CD	¸
206	CE	¸
207	CF	¸
208	D0	¸
209	D1	¸
210	D2	¸
211	D3	¸
212	D4	¸
213	D5	¸
214	D6	¸
215	D7	¸
216	D8	¸
217	D9	¸
218	DA	¸
219	DB	¸
220	DC	¸
221	DD	¸
222	DE	¸
223	DF	¸

Dec	Hex	Char
224	E0	α
225	E1	β
226	E2	γ
227	E3	π
228	E4	σ
229	E5	σ
230	E6	μ
231	E7	τ
232	E8	φ
233	E9	θ
234	EA	ρ
235	EB	ς
236	EC	ϖ
237	ED	φ
238	EE	ε
239	EF	η
240	F0	≡
241	F1	±
242	F2	∞
243	F3	∞
244	F4	∞
245	F5	∞
246	F6	÷
247	F7	≈
248	F8	◊
249	F9	•
250	FA	•
251	FB	¸
252	FC	¸
253	FD	¸
254	FE	¸
255	FF	¸

I attach the ASCII table as an example. On the Internet, however, I found other options. The solution of this crop circle should be in the hands of a computer specialist.

### Health Pávková Zdenka

---

This 'clock like' CC suggest 'minutes' in a 24 hours day. Reported on August 7th 2011, the number of minutes in a day (i.e. 1440) may be pointing again the day of the eclipse on August 28th 2007 because is exactly 1440 days backward...

What about the second part of it? 12 hours completed give us 720 minutes, and maybe those numbers decoded by Laurent Kalensky (0-6-5-9-8-0-3-6-1-5-2-4-0) are meaningful: without an obvious beginning and ending, a simple addition then of those twelve ciphers means 49. If the artist doesn't need a multiplication for his message, they are plain numbers in a completion to 60 reference, so  $49 \times 60$  is equal to 2,940, which again too, is the number of days between the eclipse of August 11 1999 and that another one of August 28th 2007 (both eclipse days included), as interpreted on the previous days serpent (West Woodhay). Perhaps

The point? Well, after Wilton Windmill, Kingston Coombes, East Kennett and West Woodhay, this is the fifth crop circle of the season mathematically and astronomically pointing a general underlying, and developing, 'archetypal myth' (besides other CC's more symbolical but convergent), intersecting dimensionally our known reality. The eight years period between the grand cross alignment of 1999 and August 18th 2007, has August 18th 2005, as suggested after our interpretation of the West Woodhay serpent, as a breaking point.

May I share some dessert for today's panorama? Dealing with breaking point, Time, Change and superior dimensions that amazing date relates in Mayan terms with December 21st 2012 after a, hard to understand, unconventional event having place in China, when that watch clock engraved with the word 'swiss' maybe as a symbol for perfection in timing, in the form of a ring which is very important, was discovered inside a Ming Tomb closed for centuries on the precise date of December 11th 2008, if you remember this. The miniature watch ring was on 10:06 hours, which is the exact half of 2012... and the message was as follows:

18/8/2005 -- (11/12/2008) - [260] - (28/8/2009) -- 21/12/201

There's a ring (a very mayan 260 days ring) around the middle point between the two extremes of the time period.

In fact, mentioning this, in our today's 'watch like' crop circle those value marks could also be multiplied by 6 (ten possible digits by 6 for 60 frames), then the obtained 49 from their simple addition becomes 294 and we'd have a 720 too (because of 12 completed 'hours'): a) pointing beyond 28/8/2009 the next August 18th this year 2011 (720 days after); b) also 294 days (remember our frequent 292 mayan count) after the last Venus conjunction, as in West Woodhay: again August 18th 2011.

I wouldn't expect anything extraordinary on that future date (who knows). I guess this is more about the deep meaning of what's involved in the events of this archetypal developing, dealing with four constellations aligned in cross, 24 seats, and among others a not allowed sort of cosmic transgression committed by some terrestrial power (because of Wilton Windmill). We'll see (if this game of communication follows, and of course... the real thing).

### Iván Castillo Méndez

---

## The "Temple Farm" Crop Circle.

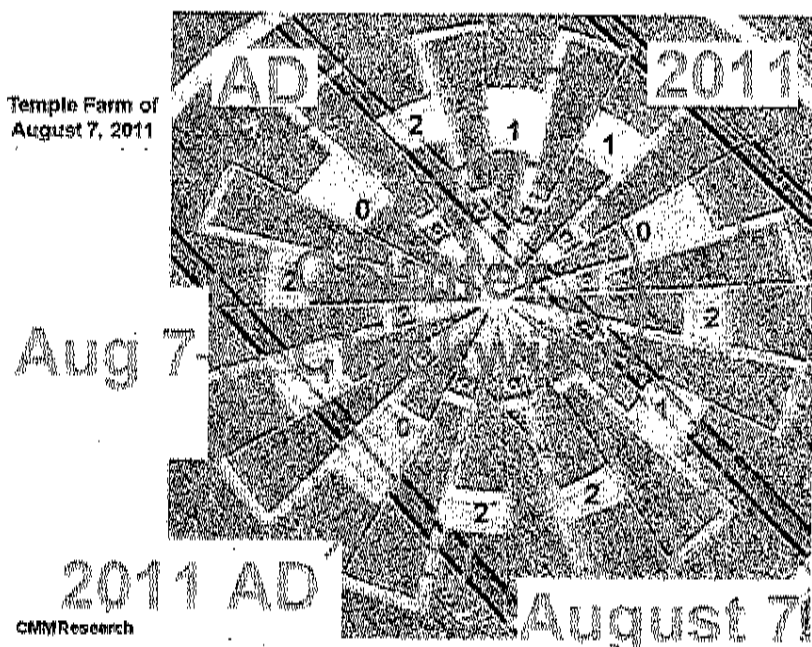

**Note:** Translated words and coded shapes like the ‘Temple Farm Crop Circle’ indicate unusual relationships between the character positions in the word(s) being translated and result of the translation. God (UFO/ET) talks to us through the ET Corn Gods language translation of words. Words and groups of words are like computer programs which explode into a family of predetermined meanings.

**Temple Farm:**

Tc-66-66 .. = “G”. m is 12, ac, c+66+66 .. = “Mc”.

Ple is Phosphorus, backwards, “SRG”, backwards is “GRS”. (Pho’s cancel. Us-

66-66 ... = “G”) G is Seven, “Sn”, 19 AD, book 58, 58+66+66 ... = “ET”. (eve = 5225, they

cancel). R + 66+66 ... = “AP”, “Alien”. (Al is Aluminum. Um’s cancel. i is 9, nine, “ie”. n’s cancel)

S is 0+66+66 ... = “Mt”, “Mts”, book 44. 44+66 = “70”, “Go”.

Therefore:

**Temple = “Game, God/Alien/ET”.**

P is P+66, book Rev, “Prev”. V is 5, book Dt, “Dict”. (add 0+66+66 ... = “924”, i 1212, iLL, I5050, “Ic”. Add 0+66+66 ... = “PI”.

Therefore:

**Temple = “Game Predict Play”**

**Farm:**

Fa is 61, backwards 16, “P”, Phosphorus, backwards = “GRS”, “God/Alien/ET” —see above.

Ar-66-66 ... = “52”, 5+2, “G”. F+66+66 .. = “St”. R is 14+4, “Nd” M is ac, book 44, 4+6 = “70”, “Go” M is ac, c = 100, 5050, LL, 1212, 24. 124+66+66 .. = “ET”.

Therefore:

**Farm = “GOD/Alien/ET Game”.**

**Temple Farm = "Game, God/Alien/ET, God/Alien/ET Game".**

**Temple Farm = "Game Predict Play, God/Alien/ET Game".**

**Temple Farm = "Game Predict Play, Stand God (ET)".**

*Note:* The words "Temple Farm" decodes into two definitions which mean the same thing. The translation of the graphics shows that the date "August 7, 2011 AD" —twice, is the result of the translation exercise.

## **Translation of the Crop Circle Graphics:**

*Note* that the original pattern from the *Temple Farm* field does not contain the numbers, one each of the twelve spokes, starting at about 25 after the hour on the 12 spoke clock --- going counter clockwise.

**The Numbers "21".**

21+66 = "87", "August 7" — the date the Crop Circle was reported.

**The Numbers "2011".**

This year.

**The Numbers "20".**

20 is T, backwards is 02, B, Boron, "Bad", 2 Ad, book 41, backwards = "AD". (or- 66-66 .. = "0", drop it. Drop the "o").

Therefore:

20 = "AD".

*The first series of numbers starting "21 2011 20" = "August 7,*

*2011 AD" — the complete the Crop Circle was reported.*

**"21 2011 20" = "August 7, 2011 AD"**

**The Numbers "21".**

21+66 = "87", "August 7" the date this Crop Circle was reported. Therefore:

21 = "August 8".

**The Numbers "02":**

The letters "02" = "OB", book "Obadiah".

**Obadiah:**

Ob is book 31, "20+11", "2011". Iah: I is 9, ix, i 2+4, "IF", f-i. C. Cah = "Ha". Therefore:

02 = "2011 AD, Ha".

Therefore:

**21 2011 20, 21 02 = "August 7, 2011 AD, August 7, 2011 AD, Ha".**

*Note:* This Crop Circle is intended by "GOD/UFO/ET/Alien" as a training exercise about the *ET Corn Gods* language. You may note that a previous Crop Circle (reported Aug 3) was a "Clock" —a forerunner of this Crop Circle.

Visit: [www.ETCornGods.com](http://www.ETCornGods.com) and [www.ufoetblog.com](http://www.ufoetblog.com)

George Simpson

CC decryption - Temple Farm, Nr Rockley, Wiltshire. Reported 7th August

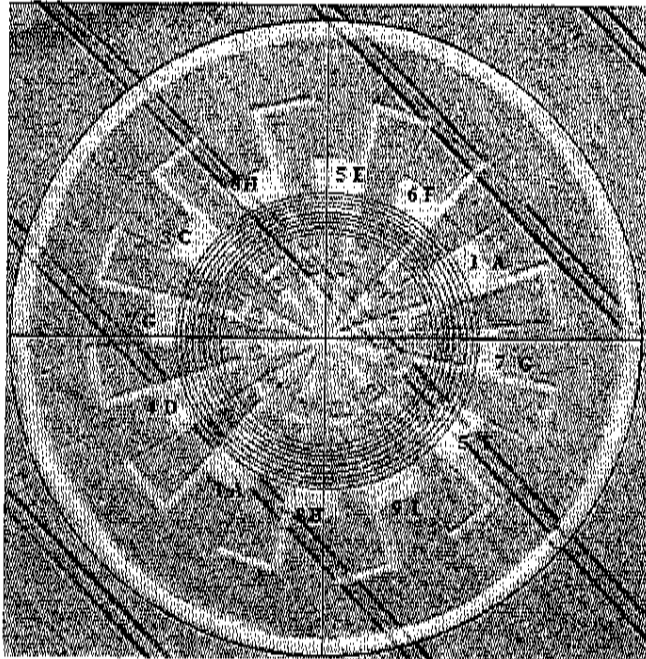

I think I made successful decryption of Crop Circle which appeared at Temple Farm, Nr Rockley, Wiltshire. (Reported 7th). I made some transformations to the aerial photos (but it's not perfect as it can look - upper part was a little bit shrunk so I had to make some corrections to the circles) and after some trial and error I got to this message: AGE I HAD G CHEF (175981473856) (gaps were chosen with respect to field tracks, 123456789 - ABCDEFGHI)

David K.

\*\*\*\*\*▶

**Jump Into a New Life**

\*\*\*\*\*

Take the Jump & Change Your Life  
 Download Free Audio  
[www.QuantumJumping.com](http://www.QuantumJumping.com)

**Click to Start**



BACK



Mark Fussell & Stuart Dike